



NATURAL STONE BOX







INDICE

INDICE INHALTSVERZEICHNIS INDEX

- 4 Introduzione - Introduction
Einführung - Introduction
- 5 Sostenibilità - Durabilité
Nachhaltigkeit - Sustainability
- 6 Destinazioni d'uso - Destinations d'usage
Verwendungszweck - Intended use
- 16 *PRO Gabbioni - Gabions*
Gabionen - Gabions
- 20 *SLIM Gabbioni - Gabions*
Gabionen - Gabions
- 22 *Gabbioni inscatolati - Gabions en boîte*
Gabionen im kasten - Gabions in box
- 23 Installazione Gabbioni - Installation des Gabions
Gabioneninstallation - Gabions Installation
- 24 *Muri - Murs*
Wände- Walls
- 26 Installazione Muri - Installation des murs
Wandinstallation Walls installation
- 27 *MINI GABION*



IT
NATURAL STONE BOX è la **soluzione tecnica e decorativa di gabbioni e muri componibili**: una scelta pratica e duratura che garantisce risultati eccezionali per estetica e solidità. Cinque diverse tipologie ecosostenibili, facili da montare, drenanti e per infinite destinazioni d'uso.

FR
NATURAL STONE BOX est la **solution technique et décorative pour les gabions et murs modulaires**: un choix pratique et durable qui garantit des résultats exceptionnels en termes d'esthétique et de solidité. Cinq types différents éco-durables, faciles à assembler, drainants et pour des utilisations infinies.

DE
NATURAL STONE BOX ist die **technische und dekorative Lösung für Gabionen und Modularwände**: eine praktische und langlebige Wahl, die außergewöhnliche Ergebnisse in Bezug auf Ästhetik und Stabilität garantiert. Fünf verschiedene ökologisch nachhaltige Typen, die einfach zu montieren, zu entleeren und für verschiedene Einsatzmöglichkeiten verwendet werden können.

EN
NATURAL STONE BOX is the **technical and decorative solution for gabions and modular walls**: a practical and long-lasting choice that guarantees exceptional results in terms of aesthetics and solidity. Five different eco-sustainable types, easy to assemble, draining and for infinite uses.

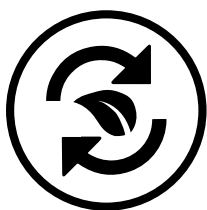

ECOSOSTENIBILE
ÉCOLOGIQUE
UMWELTFREUNDLICH
ECO FRIENDLY



FACILE DA MONTARE
FACILE À ASSEMBLER
LEICHT ZUSAMMENZUBAUEN
EASY TO ASSEMBLE

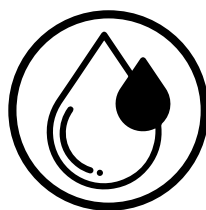

DRENANTE
DRAINANT
ENTLEEREN
DRAINING

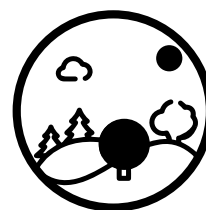

INFINITE DESTINAZIONI
DESTINATIONS INFINIES
UNENDLICHE ZIELE
COUNTLESS DESTINATIONS





SOSTENIBILITÀ DURABILITÉ - NACHHALTIGKEIT - SUSTAINABILITY

- Riutilizzabile infinite volte
- Materiale riciclabile: sia la rete che gli inerti
- Prodotto con materiale riciclato
- Réutilisable un nombre infini de fois
- Matériau recyclable : les treillis aussi bien que les granulats
- Fabriqué avec des matériaux recyclés
- Wiederverwendbar
- Recyclbares Material: sowohl das Netz als auch die Zuschlagstoffe
- Hergestellt aus recyceltem Material
- Reusable infinite times
- Recyclable material: both the cage and the aggregates
- Made with recycled material

Granulati Zandobbio è un'azienda impegnata nella salvaguardia dell'ambiente e adotta in ogni sua attività produttiva soluzioni sostenibili e certificate. Tutti i prodotti Natural Stone Box riducono i rischi naturali antropologici, rispettando l'ambiente, aumentando la sicurezza delle persone e migliorando la loro vita.

Granulati Zandobbio est une entreprise engagée dans la protection de l'environnement et adopte des solutions durables et certifiées dans toutes ses activités de production. Tous les produits Natural Stone Box réduisent les risques naturels anthropologiques, en respectant l'environnement, en augmentant la sécurité des personnes et en améliorant leur vie.



Granulati Zandobbio ist ein Unternehmen, das sich dem Schutz der Umwelt verschrieben hat und bei allen Produktionsaktivitäten nachhaltige und zertifizierte Lösungen einsetzt. Alle Produkte von Natural Stone Box reduzieren anthropologische Naturrisiken, schonen die Umwelt, erhöhen die Sicherheit der Menschen und verbessern ihr Leben.

Granulati Zandobbio is a company committed to protecting the environment and adopts sustainable and certified solutions in all its production activities. All Natural Stone Box products reduce anthropological natural risks, respecting the environment, increasing people's safety and improving their lives.



DESTINAZIONI D'USO

DESTINATIONS D'USAGE - VERWENDUNGSZWECK - INTENDED USE



RECINZIONE
CLÔTURE
ZAUN
FENCE

P.8



ARREDO URBANO
MOBILIER URBAIN
STRASSENMÖBEL
STREET FURNITURE

P.9



BACINI ACQUATICI
BASSINS D'EAU
WASSERBECKEN
WATER BASINS

P.10



MURI DI CONTENIMENTO
MURS DE SOUTÈNEMENT
STÜTZMAUERN
RETAINING WALLS

P.11



**PARETI DECORATIVE
MURS DÉCORATIFS
DEKORATIVE WÄNDE
DECORATIVE WALLS**

P.12



**VERDE VERTICALE
MUR VÉGÉTAL
VERTIKALE GRÜN
VERTICAL GREENERY**

P.13



**BARRIERE ANTITERRORISMO
BARRIÈRES ANTITERRORISTES
ANTI-TERRORISMUS-BARRIEREN
ANTI-TERROR BARRIERS**

P.14



**STRUTTURE PORTANTI
STRUCTURES PORTANTES
LAGERSTRUKTUREN
WEIGHT BEARING STRUCTURES**

P.15

RECINZIONE - CLÔTURE - ZAUN - FENCE

Permettono di creare recinzioni resistenti ma anche pareti divisorie decorative.



Ils permettent de créer des clôtures résistantes mais aussi des cloisons décoratives.

Mit ihnen können Sie widerstandsfähige Zäune, aber auch dekorative Trennwände erstellen.

They allow you to create resistant fences but also decorative partition walls.

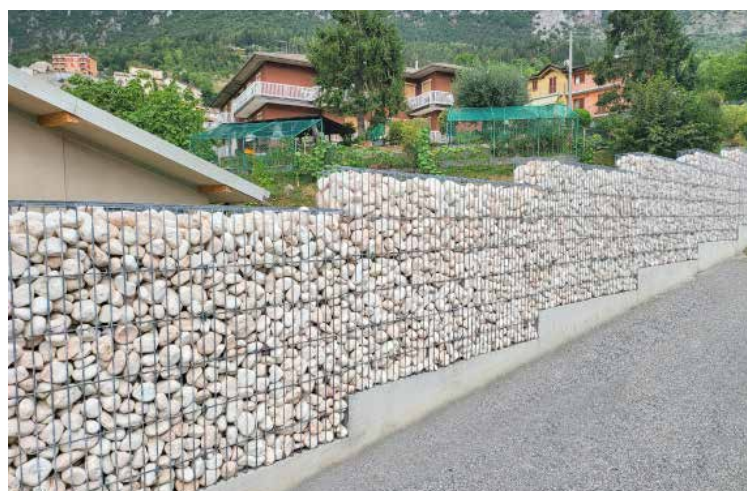

ARREDO URBANO - MOBILIER URBAIN - STRASSENMÖBEL - STREET FURNITURE



Ideali come elementi di arredo urbano, possono diventare panchine, fioriere, fontane o tavolini.

Idéaux comme éléments de mobilier urbain, ils peuvent devenir des bancs, des jardinières, des fontaines.

Sie eignen sich ideal als Elemente der Stadtmöblierung und können als Bänke, Pflanzgefäßen, Brunnen oder Tischen genutzt werden.

Ideal as elements of street furniture, they can become benches, planters, fountains or tables.



BACINI ACQUATICI - BASSINS D'EAU - WASSERBECKEN - WATER BASINS

Creano una struttura anti erosione da utilizzare nei rivestimenti spondali di bacini acquatici.



Ils créent une structure anti-érosive à utiliser dans les revêtements des berges des bassins d'eau.

Sie bilden eine erosionshemmende Struktur, die in der Uferauskleidung von Wasserbecken eingesetzt wird.

They create an anti-erosion structure to be used for bank protection of water basins.



MURI DI CONTENIMENTO - MURS DE SOUTÈNEMENT - STÜTZMAUERN - RETAINING WALLS



Possono essere utilizzati per creare muri decorativi e di sostegno, per contenere la spinta del terreno.
Ils peuvent être utilisés pour créer des murs décoratifs et de soutènement, pour contenir la pression du sol.
Sie können zur Herstellung von Zier- und Stützmauern verwendet werden, um den Druck des Bodenseinzudämmen.
They can be used to create decorative and retaining walls, to contain the pressure of the ground.



PARETI DECORATIVE - MURS DÉCORATIFS - DEKORATIVE WÄNDE - DECORATIVE WALLS



Utilizzati come pareti decorative per rivestire o separare luoghi pubblici e privati.

Utilisés comme murs décoratifs pour couvrir ou séparer les lieux publics et privés.

Wird als dekorative Wand zum Abdecken oder Trennung von öffentlicher und privater Bereiche verwendet.

Used as decorative walls to cover or separate public and private places.



VERDE VERTICALE - MUR VÉGÉTAL - VERTIKALE GRÜN - VERTICAL GREENERY



Sono un'ottima base per tutte le piante rampicanti per la realizzazione del verde verticale.

Ils constituent une excellente base pour toutes les plantes grimpantes pour la création de verdure verticale.

Sie sind eine hervorragende Basis für alle Kletterpflanzen zur Schaffung vertikaler Begrünung.

They are an excellent base for all climbing plants for the creation of vertical greenery.



BARRIERE ANTITERRORISMO - BARRIÈRES ANTITERRORISTES - ANTI-TERRORISMUS-BARRIEREN - ANTI-TERRORBARRIERS

Solidi dissuasori protettivi per aree urbane affollate, utili anche come barriere antiterrorismo.



Bornes de protection solides pour les zones urbaines bondées, également utiles comme barrières antiterroristes.

Stabile Schutzpoller für städtische Gebiete, auch nützlich als Anti-Terror-BARRIEREN.

Solid protective dissuaders for crowded urban areas, also useful as anti-terrorism barriers.



STRUTTURE PORTANTI - STRUCTURES PORTANTES - LAGERSTRUKTUREN - WEIGHT BEARING STRUCTURES



Ideali come ottima base portante per le strutture, idonei per la costruzione di fondazioni.

Idéaux comme excellente base portante pour les structures, adaptés aux fondations de bâtiments.

Ideal als hervorragende tragende Unterlage für Bauwerke, geeignet für Gebäudefundamente.

Ideal as an excellent load-bearing base for structures, suitable for building foundations.



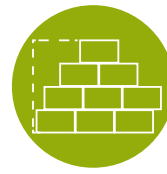

GABBIONI PROFESSIONALI in rete elettrosaldata con filo di diametro 5,8 mm zincato a caldo in classe A (Zn/Al 95/5).
 Gabions PROFESSIONNELS en treillis électrosoudé avec fil galvanisé à chaud de 5,8 mm de diamètre classe A (Zn/Al 95/5).
 PROFESSIONELLE Gabionen aus elektrogeschweißtem Gitter mit feuerverzinktem Draht der Klasse A (Zn/Al 95/5) mit 5,8 mm Durchmesser.
 PROFESSIONAL electrowelded mesh gabions with 5.8 mm diameter wire hot-dip galvanized in class A (Zn/Al 95/5).

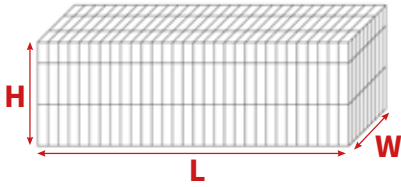

PESO - POIDS
GEWICHT - WEIGHT
[kg]

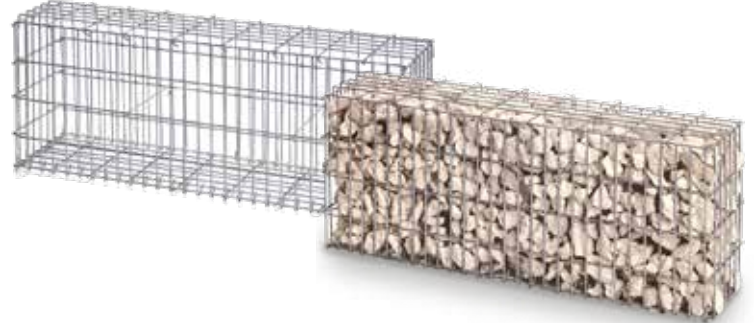

	TIPO TYPE TYP TYPE	L [cm]	W [cm]	H [cm]	VUOTO VIDE LEER EMPTY	PIENO REMPI VOLL FULL
1		50	50	50	10	200
2		100	50	50	16	420
3		100	50	100	24	860
4		150	50	100	38	1200
5		100	100	100	42	1720
6		150	100	100	50	2600
7		200	100	100	56	3320
8		200	50	100	42	1740
9		200	50	50	30	850
10		150	50	50	22	600
11		150	100	50	42	1300
12		200	100	50	42	1670
13		100	100	50	16	835
14		100	25	50	10	190
15		100	25	100	16	400

POSSONO ESSERE CONSEGNATI PRERIEPITI O VUOTI
 ILS PEUVENT ÊTRE LIVRÉS PRÉ-REMP LIS OU VIDES
 SIE KÖNNEN GEFÜLLT ODER LEER GELIEFERT WERDEN
 THEY CAN BE DELIVERED PRE-FILLED OR EMPTY

INERTI STANDARD - GRAVIER STANDARD
 STANDARDAGGREGATE - STANDARD AGGREGATES



BIANCO ZANDOBBIO



GIALLO MORI



VERDE ALPI



NERO EBANO



OCCHIALINO



ROSSO VERONA



CARATTERISTICHE

CARACTÉRISTIQUES - EIGENSCHAFTEN - CHARACTERISTICS



INDEFORMABILE, RESISTENTE E SOLIDO, DOTATO DI TIRANTI PER GARANTIRE LA FORMA E LA SOLIDITÀ

Indéformable, résistant et solide, équipé de tirants pour garantir la forme et la solidité
Nicht verformbar, widerstandsfähig und solide, ausgestattet mit Zugstangen, um die Form und Festigkeit zu gewährleisten
Non-deformable, resistant and solid, equipped with tie rods to guarantee the shape and solidity

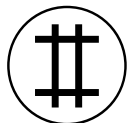

DIMENSIONI DELLA MAGLIA: 5x20 cm E GRANULOMETRIA CONSIGLIATA 70-150 mm

Taille des mailles : 5x20cm et granulométrie recommandée 70-150 mm
Maschengröße: 5x20cm und empfohlenegranulometrie 70-150 mm
Mesh size: 5x20cm and recommended granulometry 70-150 mm



IDEALE PER IL CONTENIMENTO TERRA PERCHÈ PUÒ SOSTENERE CARICHI ELEVATI

Idéal pour le confinement de la terre car il peut supporter des charges élevées
Ideal zur Erdeindämmung, da es hohe Lasten TRAGEN kann
Ideal for ground retaining because it can support high loads

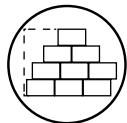

ALTEZZE ELEVATE GRAZIE ALLA ROBUSTA E SOLIDA STRUTTURA, POSSONO REGGERE GRANDI PESI

Grandes hauteurs grâce à la structure robuste et solide, ils peuvent supporter des poids importants
Dank der robusten und soliden Struktur können sie große Gewichte tragen
High heights can hold great loads thanks to the robust and solid structure

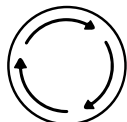

RIUTILIZZABILE INFINITE VOLTE

Réutilisable un nombre infini de fois
Wiederverwendbar
Reusable infinite times

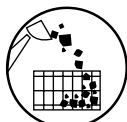

RIEMPIMENTO IN LOCO, POSSONO ESSERE VENDUTI PRERIEPITI PRONTI PER LA POSA

Remplissage sur place, ils peuvent être vendus pré-remplis prêts pour être posés
Nach der Befüllung vor Ort können sie vorgefüllt und einbaubereit verkauft werden
Filling on site, they can be sold pre-filled ready for installation



VELOCITÀ DI INSTALLAZIONE, CON I GABBIONI PRERIEPITI I TEMPI IN CANTIERE SI VELOCIZZANO

Rapidité de pose, avec gabions pré-remplis, les temps sur chantier sont accélérés
Schnelle Installation, MIT vorgefüllten Gabionen werden die Zeiten vor Ort verkürzt
Speed of installation, with pre-filled gabions, times on site are speeded up



RISPARMIO DELLE ATTIVITÀ IN CANTIERE GRAZIE AI GABBIONI PRERIEPITI E GIÀ MONTATI

Économies sur les activités de chantier grâce aux gabions pré-remplis et déjà assemblés
Einsparung von Baustellenaktivitäten durch vorgefüllte und bereits montierte Gabionen
Savings in construction site activities thanks to the pre-filled and already assembled gabions

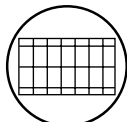

DISPONIBILE ANCHE VUOTI, MONTATI O NON ASSEMBLATI

Aussi disponible vide, assemblé ou non assemblé
Auch leer, montiert oder nicht montiert erhältlich
Also available empty, assembled or not assembled



FACILI DA ASSEMBLARE, IN POCHE MOSSE È POSSIBILE MONTARE I GABBIONI VUOTI IN LOCO

Faciles à assembler, en quelques étapes seulement il est possible d'assembler les gabions vides sur place
Einfache Montage, in nur wenigen Schritten ist die Montage der leeren Gabionen vor Ort möglich
Easy to assemble, in just a few steps it is possible to assemble the empty gabions on site

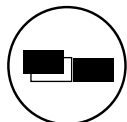

MOVIMENTABILE PIENO, IDEALE PER OTTIMIZZARE I TEMPI IN CANTIERE

Possibilité de le déplacer pré-rempli, idéal pour optimiser les temps sur site
Vollständig beweglich, ideal zur Optimierung der Zeit vor Ort
Fully movable, ideal for optimizing time on site



GABBIA DRENANTE PERMETTE ALL'ACQUA DI FLUIRE

La cage de drainage permet à l'eau de s'écouler
Der Entwässerungskäfig ermöglicht den Wasserfluss
Draining cage allows water to flow

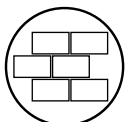

I GABBIONI POSSIEDONO GRANDE MODULARITÀ

Les gabions possèdent une grande modularité
Gabionen verfügen über eine große Modularität
Gabions possess great modularity



FONOASSORBENTI, I GABBIONI PRO POSSONO ESSERE UTILIZZATI COME PARETI ANTI RUMORE

Insonorisants, les gabions PRO peuvent être utilisés comme murs anti-bruit
PRO GABIONS sind schallabsorbierend und können als Lärmschutzwände eingesetzt werden
Sound-absorbing, PRO GABIONS can be used as anti-noise walls

ESEMPI DI APPLICAZIONE

EXEMPLES D'APPLICATIONS - ANWENDUNGSBEISPIELE - APPLICATIONS EXAMPLES

Le soluzioni mostrate sono puramente a titolo indicativo. Qualsiasi realizzazione deve essere realizzata a regola d'arte tenendo in considerazione i carichi strutturali, al fine di garantire la struttura sicura e stabile nel tempo.

Les solutions présentées sont purement à titre indicatif. Toute construction doit être réalisée à la perfection en tenant compte des charges structurelles, afin de garantir la sécurité et la stabilité de la structure dans le temps.

Die dargestellten Lösungen sind lediglich Richtwerte. Jede Konstruktion muss fachmännisch und unter Berücksichtigung der strukturellen Belastungen ausgeführt werden, um die Sicherheit und Stabilität der Struktur zu gewährleisten.

The solutions shown are purely indicative. Any construction must be carried out properly taking into consideration the structural loads, in order to guarantee the structure safe and stable over time.

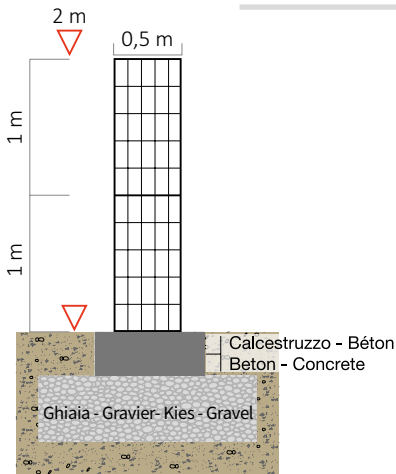

L'esempio mostra la realizzazione di una recinzione alta 2 metri al di sopra di una fondazione in calcestruzzo.

L'exemple montre la construction d'une clôture de 2 m de haut au-dessus d'une fondation en béton.

Das Beispiel zeigt den Bau eines 2m hohen Zauns über einem Betonfundament.

The example shows the construction of a 2m high fence above a concrete foundation.

L'esempio mostra un muro di contenimento terra alto 2 metri realizzato al di sopra di una fondazione in ghiaia.

L'exemple montre un mur de soutènement de 2 m de haut construit sur une fondation en gravier.

Das Beispiel zeigt eine 2 m hohe Stützmauer, die auf einem Kiesfundament errichtet wurde.

The example shows a 2m high retaining wall built on top of a gravel foundation.

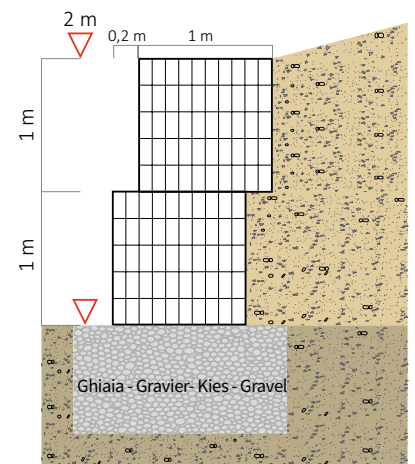

L'esempio mostra un muro di contenimento terra alto 3 metri realizzato al di sopra di una fondazione in ghiaia.

L'exemple montre un mur de soutènement de 3 m de haut construit sur une fondation en gravier.

Das Beispiel zeigt eine 3 m hohe Stützmauer, die auf einem Kiesfundament errichtet wurde.

The example shows a 3m high retaining wall built on top of a gravel foundation.

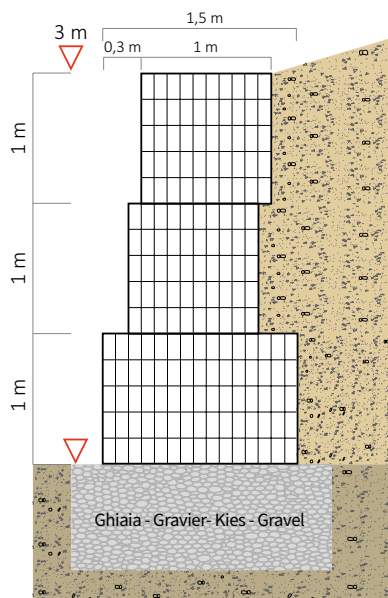

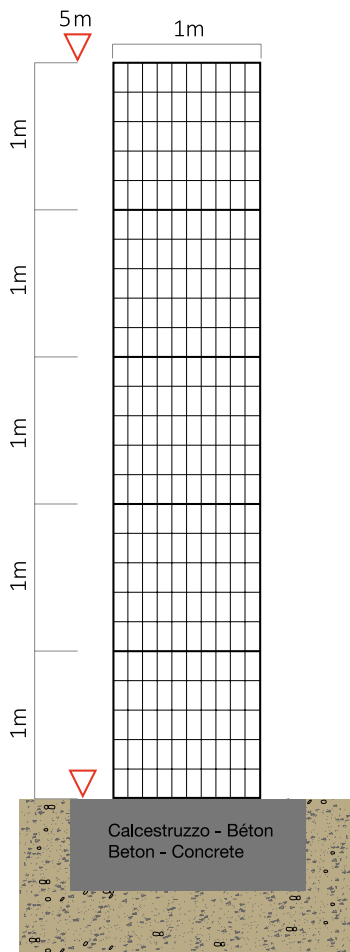

L'esempio mostra la realizzazione di una recinzione alta 5 metri al di sopra di una fondazione in calcestruzzo.

L'exemple montre la construction d'une clôture de 5 m de haut au-dessus d'une fondation en béton.

Das Beispiel zeigt den Bau eines 5m hohen Zauns über einem Betonfundament.

The example shows the construction of a 5m high fence above a concrete foundation.

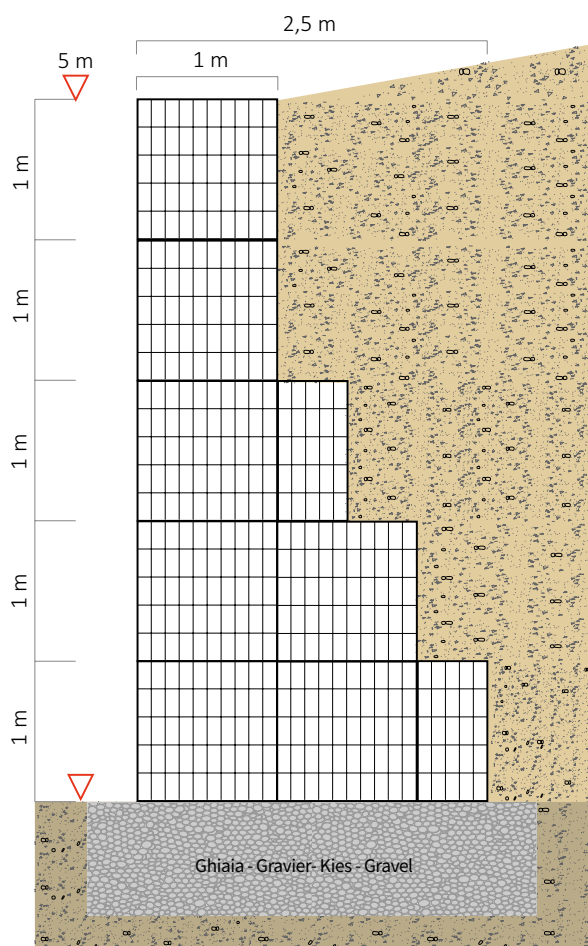

L'esempio mostra un muro di contenimento terra alto 5 metri realizzato al di sopra di una fondazione in ghiaia.

L'exemple montre un mur de soutènement de 5 m de haut construit sur une fondation en gravier.

Das Beispiel zeigt eine 5 m hohe Stützmauer, die auf einem Kiesfundament errichtet wurde.

The example shows a 5m high retaining wall built on top of a gravel foundation.



GABBIONI METALLICI realizzati con filo di diametro 3,8 mm zincato a caldo in classe A (Zn/Al 95/5).

GABIONS MÉTALLIQUES en fil galvanisé à chaud de classe A de diamètre 3,8 mm (Zn/Al 95/5).

METALLGABIONEN aus feuerverzinktem Draht der Klasse A mit einem Durchmesser von 3,8 mm (Zn/Al 95/5).

METAL GABIONS made with 3.8 mm diameter wire hot-dip galvanized in class A (Zn/Al 95/5).

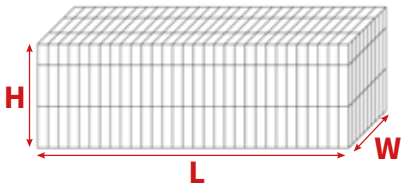

PESO - POIDS
GEWICHT - WEIGHT
[kg]

FORNITO ESCLUSIVAMENTE VUOTO
LIVRÉ UNIQUEMENT VIDE
WIRD NUR LEER GELIEFERT
SUPPLIED EMPTY ONLY

	TIPO TYPE TYP TYPE	L [cm]	W [cm]	H [cm]	VUOTO VIDE LEER EMPTY	RIEMPIMENTO REMPLISSAGE FÜLLUNG FILLING
2		100	50	50	7	375
3		100	50	100	11	750
8		200	50	100	18	1500
9		200	50	50	13	750
14		100	25	50	5	188
15		100	25	100	7	375



CARATTERISTICHE

CARACTÉRISTIQUES - EIGENSCHAFTEN - CHARACTERISTICS



RESISTENTE E SOLIDO, DOTATO DI TIRANTI PER GARANTIRE LA FORMA E LA SOLIDITÀ

Résistant et solide, équipé de tirants pour assurer la forme et la solidité
Widerstandsfähig und solide, ausgestattet mit Zugstangen, um die Form und Stabilität zu gewährleisten
Resistant and solid, equipped with tie rods to ensure the shape and solidity



DIMENSIONI DELLA MAGLIA: 5x20 cm E GRANULOMETRIA CONSIGLIATA 70-150 mm

Taille des mailles : 5x20cm et granulométrie recommandée 70-150 mm
Maschengröße: 5x20cm und empfohlene granulometrie 70-150 mm
Mesh size: 5x20cm and recommended granulometry 70-150 mm

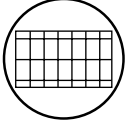

FORNITO ESCLUSIVAMENTE VUOTO, DEVE ESSERE RIEMPITO IN LOCO

Livré uniquement vide, doit être rempli sur place
Wird nur leer geliefert und muss vor Ort befüllt werden
Supplied empty only, must be filled on site

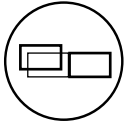

MOVIMENTABILE SOLO QUANDO IL GABBIONE SLIM È VUOTO

Il peut être déplacé uniquement lorsque le gabion Slim est vide
Nur beweglich, wenn die Slim-Gabione leer ist
Moveable only when the Slim gabion is empty

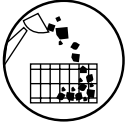

RIEMPIMENTO IN LOCO, NON PUÒ ESSERE FORNITO GIÀ PIENO

Rempli sur place, ne peut pas être fourni déjà rempli
Wird vor Ort befüllt, kann nicht befüllt geliefert werden
Filled on site, cannot be supplied filled



FORNITO IN UN SACCHETTO DOTATO DI ETICHETTA

Livré dans un sac équipé d'une étiquette
Lieferung in beschrifteter Beutel
Supplied in a labeled bag



FACILE DA MONTARE, IN POCHE MOSSE È FACILMENTE MONTABILE ANCHE DA PERSONE POCO ESPERTE

Facile à assembler, en quelques étapes seulement il peut être facilement assemblé même par des personnes inexpérimentées
Einfache Montage, mit wenigen Handgriffen auch für ungeübte Personen problemlos zu montieren
Easy to assemble, in just a few steps it can be easily assembled even by inexperienced people



OTTIMO RAPPORTO QUALITÀ/PREZZO, REALIZZATE CON IL 57% DI METALLO IN MENO RISPETTO AI PRO

Excellent rapport qualité-prix, réalisé avec 57% de moins de métal que les gabions PRO
Tolles Preis-Leistungs-Verhältnis, hergestellt aus 57 % weniger Metall als die PRO-Gabionen
Great value for money, made with 57% less metal than the PRO gabions



PRODOTTO IDEALE PER IL FAI DA TE

Produit idéal pour le bricolage
Ideales Produkt für Heimwerker
Ideal product for DIY



SOVRAPPONIBILE PER LIMITATE ALTEZZE, SI SCONSIGLIA OLTRE 1,5 m

On souhaite de les empiler jusqu'à une hauteur de 1,5 m
Aufgrund begrenzter Höhen stapelbar, über 1,5 m wird nicht empfohlen
Stackable for limited heights, not recommended over 1.5 m



GABBIONI INSCATOLATI

GABIONS EN BOÎTE - GABIONS IN DER BOX - GABIONS IN BOX

DIY

Ø
4,5 mm

GABBIONI METALLICI con filo di diametro **4,5 mm** confezionati in scatola di plastica per la vendita al pubblico.
 GABIONS MÉTALLIQUES avec un fil de 4,5 mm de diamètre emballés dans une boîte en plastique pour la vente au public.
 METALLGABIONEN mit Draht von **4,5 mm** Durchmesser, verpackt in einer Plastikbox zum Verkauf an die Öffentlichkeit.
 METAL GABIONS with **4,5 mm** diameter wire packed in plastic box for sales to the public.

	L [cm]	W [cm]	H [cm]	PESO - POIDS GEWICHT - WEIGHT [kg]	
				VUOTO VIDE LEER EMPTY	RIEMPIMENTO REPLISSAGE FÜLLUNG FILLING
	100	25	40	9	150

FORNITO ESCLUSIVAMENTE VUOTO
 LIVRÉ UNIQUEMENT VIDE
 WIRD NUR LEER GELIEFERT
 SUPPLIED EMPTY ONLY



DOTATO DI TIRANTI PER GARANTIRE LA FORMA E LA SOLIDITÀ

Équipé de tirants pour assurer forme et solidité
 Ausgestattet mit Zugstangen, um Form und Stabilität zu gewährleisten
 Equipped with tie rods to ensure shape and solidity



DIMENSIONI DELLA MAGLIA: 3,5x10 cm E GRANULOMETRIA CONSIGLIATA 50-70 mm

Taille des mailles : 3,5x10 cm et granulométrie recommandée 50-70 mm
 Maschengröße: 3,5x10 cm und empfohlene Körnung 50-70 mm
 Mesh size: 3,5x10 cm and recommended granulometry 50-70 mm

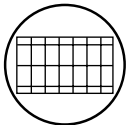

FORNITO ESCLUSIVAMENTE VUOTO, DEVE ESSERE RIEMPIUTO IN LOCO

Livré uniquement vide, doit être rempli sur place
 Wird nur leer geliefert und muss vor Ort befüllt werden
 Supplied empty only, must be filled on site

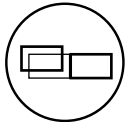

UNA VOLTA POSIZIONATO PIENO PUÒ ESSERE SPOSTATO

Une fois positionné plein il peut être déplacé
 Sobald es positioniert ist, kann es verschoben werden
 Once placed full it can be moved

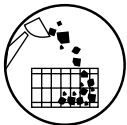

RIEMPIMENTO IN LOCO, NON PUÒ ESSERE FORNITO GIÀ PIENO

Rempli sur place, ne peut pas être fourni rempli
 Wird vor Ort befüllt, kann nicht befüllt geliefert werden
 Filled on site, cannot be supplied filled



UN PRODOTTO IDEALE PER IL FAI DA TE

Un produit idéal pour le bricolage
 Ein ideales Produkt für Heimwerker
 An ideal product for DIY



FACILE DA MONTARE, IN POCHE MOSSE È MONTABILE ANCHE DA PERSONE POCO ESPERTE

Facile à assembler, en quelques étapes seulement il peut être assemblé même par des personnes inexpérimentées
 Einfache Montage, in nur wenigen Schritten kann der Aufbau auch von ungeübten Personen durchgeführt werden
 Easy to assemble, in just a few steps it can be assembled even by inexperienced people

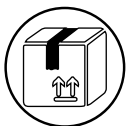

FORNITO INSCATOLATO E DOTATO DI ISTRUZIONI PER IL MONTAGGIO

Livré en boîte et équipé d'instructions de montage
 Lieferung im Karton und mit montageanleitung
 Supplied boxed and equipped with assembly instructions



INSTALLAZIONE-INSTALLATION-INSTALLATION-INSTALLATION GABIONS PRO, SLIM GABIONS & GABBIONI INSCATOLATI

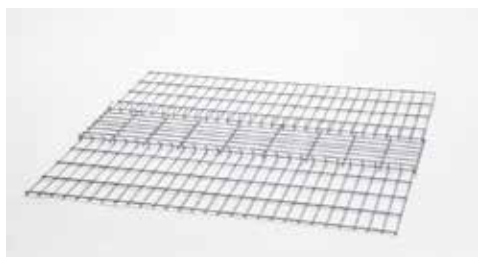

Posizionare la base incastrando i 2 laterali lunghi.
Positionnez la base en emboitant les 2 côtés longs.
Positionieren Sie die Basis, indem Sie die beiden Längsseiten ineinander stecken.
Position the base by interlocking the 2 long sides.

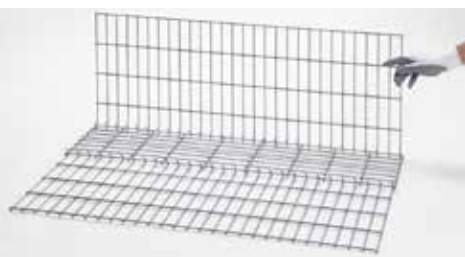

Sollevare i laterali lunghi.
Relevez les côtés longs.
Heben Sie die Längsseiten an.
Lift the long sides.



Chiudere i ganci con una pinza.
Fermes les crochets avec une pince multiprise.
Schließen Sie die Haken mit einer Zange.
Close the hooks with pliers.



Si può utilizzare un martello.
Un marteau peut être utilisé.
Ein Hammer kann verwendet werden.
A hammer can be used.

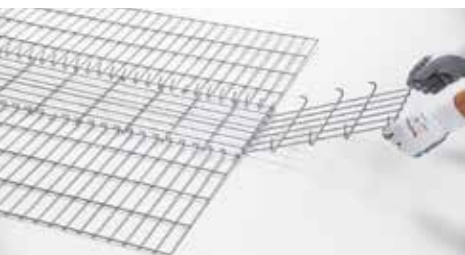

Sollevare i laterali corti.
Relevez les côtés courts.
Heben Sie die kurzen Seiten an.
Lift the short sides.



Sollevare i laterali lunghi.
Relevez les côtés longs.
Heben Sie die Längsseiten an.
Lift the long sides.

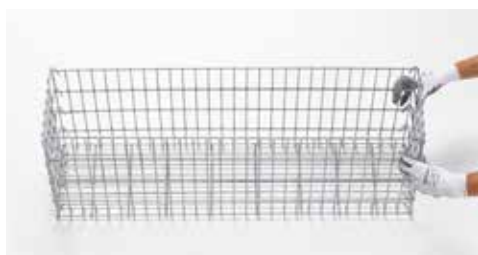

Incastrare i laterali lunghi con quelli corti.
Verrouillez les côtés longs avec ceux courts.
Verzahnen Sie die langen Seiten mit den kurzen.
Interlock the long sides with the short ones.



Chiudere i ganci con una pinza.
Fermes les crochets avec une pince multiprise.
Schließen Sie die Haken mit einer Zange.
Close the hooks with pliers.



Posizionare i tiranti all'interno.
Placez les tirants à l'intérieur.
Legen Sie die Spurstangen hinein.
Place the tie rods inside.



Posizionare il coperchio.
Placez le couvercle.
Setzen Sie den Deckel auf.
Place the lid.



Procedere con la chiusura del coperchio.
Procédez à la fermeture du couvercle.
Fahren Sie mit dem Schließen des Deckels fort.
Proceed with closing the lid.



Gabbione Natural Stone Box montato.
Gabion Natural Stone Box monté.
Gabionen-Natursteinkasten montiert.
Gabion Natural Stone Box mounted.



Riempire il gabbione con i ciottoli o granulati scelti.
Remplissez le gabion avec les cailloux ou les graviers choisis.
Füllen Sie die Gabione mit den ausgewählten Kieselsteinen oder Granulat.
Fill the gabion with the chosen pebbles or gravels.



Chiudere il coperchio.
Fermes la couverture.
Schließen Sie des Deckels.
Close the lid.



Stringere bene i ganci con una pinza.
Serrez bien les crochets avec une pince multiprise.
Ziehen Sie die Haken mit einer Zange gut fest.
Tighten the hooks well with pliers.

SCARICA le istruzioni di montaggio per maggiori dettagli.
TÉLÉCHARGEZ les instructions de montage pour plus de détails.
LADEN SIE die Montageanleitung herunter, um weitere Informationen zu erhalten.
DOWNLOAD the assembly instructions for more details.



MURI

MURS - WÄNDE - WALLS

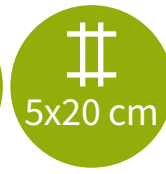

Muri componibili disponibili in 5 altezze, sviluppati per realizzare pareti poco profonde. Ideali per quelle aree con spazi limitati, dove non si possono installare i gabbioni profondi 50cm. Nonostante il muro sia alto e **profondo solo 25 cm**, con filo **Ø 5,8 mm** zincato a caldo in classe A (Zn/Al 95/5), risultano essere stabili e sicuri perchè dotati di **pali** ancorati al terreno.

Murs modulaires disponibles en 5 hauteurs, conçus pour créer des murs peu profonds. Idéaux pour les zones à espace limité, où des gabions de 50 cm de profondeur ne pourraient pas être installés. Bien que le mur soit haut et seulement de 25 cm de profondeur, avec du fil galvanisé à chaud de Ø 5,8 mm en classe A (Zn/Al 95/5), ils sont stables et sûrs car ils sont équipés de poteaux ancrés au sol.

Modulare Wände, erhältlich in 5 Größen, entwickelt für die Schaffung flacher Wände. Geeignet für Bereiche mit begrenztem Platzangebot, in denen 50 cm tiefe Gabionen nicht installiert werden können. Die Mauer sind hoch und nur **25 cm tief**, sind mit feuerverzinktem Draht **Ø 5,8 mm** der Klasse A (Zn/Al 95/5) stabil und sicher, da sie mit im Boden verankerten **Stangen** ausgestattet sind.

Modular walls available in 5 heights, developed to create shallow walls. Suitable for those areas with limited space, where 50cm deep gabions cannot be installed. Although the wall is high and only 25 cm deep, with Ø 5.8 mm hot-dip galvanized wire in class A (Zn/Al 95/5), they are stable and safe because they are equipped with poles anchored to the ground.

CARATTERISTICHE

CARACTÉRISTIQUES - EIGENSCHAFTEN - CHARACTERISTICS

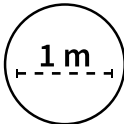

FORNITO IN MULTIPLI DI 1 METRO E ADATTABILI IN LUNGHEZZA IN CANTIERE

Livré par multiples de 1 mètre et réglable en longueur sur place
Wird in Vielfachen von 1 Meter geliefert und kann vor Ort in der Länge angepasst werden
Supplied in multiples of 1 meter and adjustable in length on site

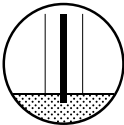

DOTATO DI PALO INTERNO PER GARANTIRE LA SOLIDITÀ E STABILITÀ

Équipé d'un poteau interne pour assurer la solidité et la stabilité
Ausgestattet mit einer Innenstange, um Festigkeit und Stabilität zu gewährleisten
Equipped with an internal pole to ensure solidity and stability



PRODOTTO RESISTENTE E SOLIDO, DOTATO DI TIRANTI INTERNI

Produit résistant et solide, équipé de tirants internes
Widerstandsfähiges und solides Produkt, ausgestattet mit innenliegenden Zugstangen
Resistant and solid product, equipped with internal tie rods

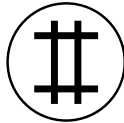

MAGLIA 5x20 cm, GRANULOMETRIA CONSIGLIATA 70-150 mm

Taille des mailles: 5x20cm et granulométrie recommandée 70-150 mm
Maschengröße: 5x20cm, empfohlene Größe 70-150 mm
Mesh size: 5x20cm and recommended granulometry 70-150 mm

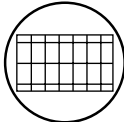

FORNITO ESCLUSIVAMENTE VUOTO

Livré uniquement vide
Wird nur leer geliefert
Supplied empty only

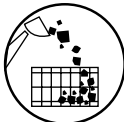

RIEMPIMENTO IN LOCO

Remplissage sur place
Abfüllung vor Ort
Filling on site



TIPO TAPER TYP TYPE	W [cm]	H [cm]	PESO - POIDS GEWICHT - WEIGHT [kg]	
			VUOTO VIDE LEER EMPTY	RIEMPIMENTO REMPLISSAGE FÜLLUNG FILLING
A	25	100	19	375
B	25	150	27	565
C	25	180	31	675
D	25	200	34	750
E	25	250	43	940

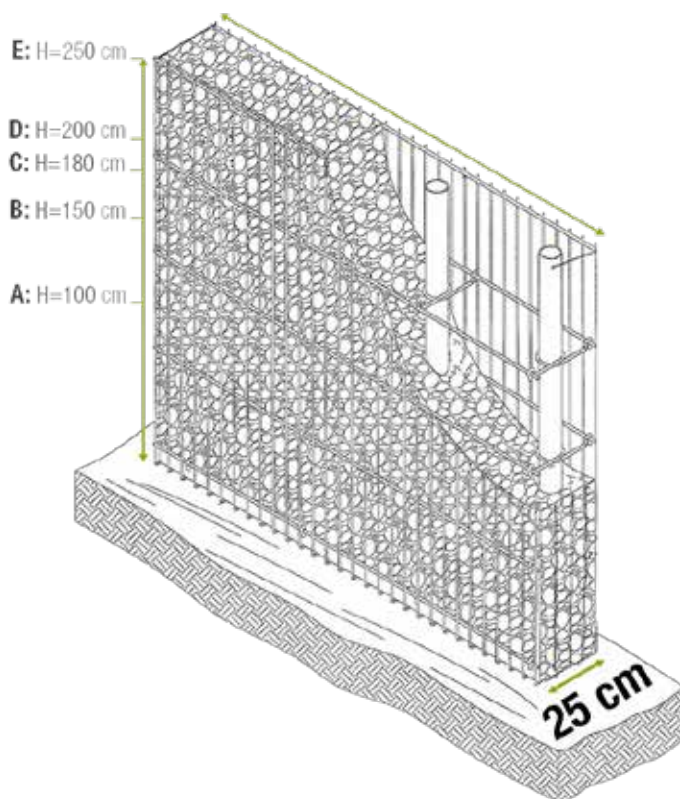

FORNITO ESCLUSIVAMENTE VUOTO
LIVRÉ UNIQUEMENT VIDE
WIRD NUR LEER GELIEFERT
SUPPLIED EMPTY ONLY



INSTALLAZIONE-INSTALLATION-INSTALLATION-INSTALLATION GABBIONI MURI - MURS EN GABIONS - GABIONEN WÄNDE - WALLS GABIONS

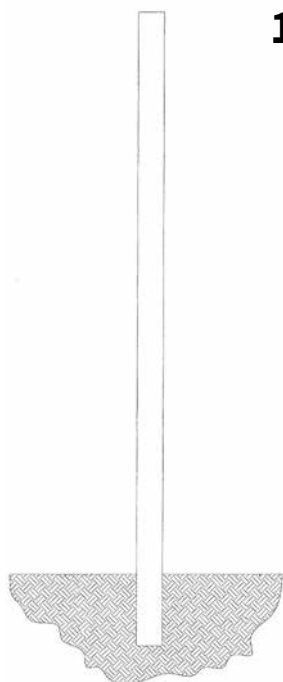

- 1** Fissare il primo palo nel basamento in calcestruzzo, distante 20 cm dal punto di partenza e 65 cm dal secondo palo. Posizionare i successivi pali a 100 cm di distanza dal precedente.

Fixez le premier poteau dans la base en béton, à 20 cm du point de départ et à 65 cm du deuxième poteau. Placez les poteaux suivants à 100 cm du précédent.

Befestigen Sie den ersten Pfosten im Betonsockel, 20 cm vom Startpunkt und 65 cm vom zweiten Pfosten entfernt. Platzieren Sie die nächsten Pfosten 100 cm vom vorherigen entfernt.

Fix the first pole to the concrete base, 20 cm away from the starting point and 65 cm from the second post. Place the next poles 100 cm away from the previous one.

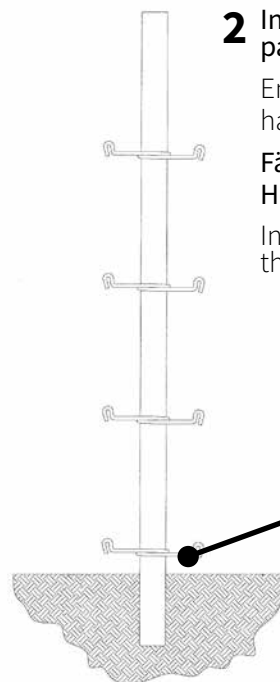

- 2** Infilare i ganci lungo l'altezza del palo.

Enfilez les crochets le long de la hauteur du poteau.

Fädeln Sie die Haken entlang der Höhe des Pfostens ein.

Insert the hooks along the height of the pole.

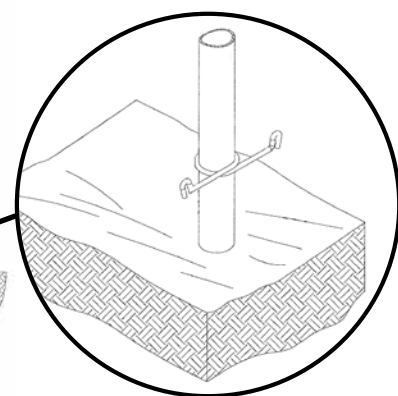

- 3** Fissare le reti laterali lunghe agganciandole in serie su ambo i lati con i ganci preinfilati, aggiungere i tiranti e chiudere il muro con i lati corti. Riempire con gli inerti e infine installare il coperchio.

Fixez les longs treillis latéraux en les accrochant en série des deux côtés avec les crochets pré-filetés, ajoutez les tirants et fermez le mur avec les côtés courts. Remplissez d'agregats et enfin installez la couverture.

Befestigen Sie die langen Seitennetze, indem Sie sie auf beiden Seiten mit den vorgefädelten Haken in Reihe einhaken, fügen Sie die Zugstangen hinzu und schließen Sie die Wand mit den kurzen Seiten. Mit Zuschlagstoffen befüllen und abschließend die Abdeckung montieren.

Fix the long side nets by hooking them in series on both sides with the pre-inserted hooks, add the tie rods and close the wall with the short sides. Fill with aggregates and finally install the lid.

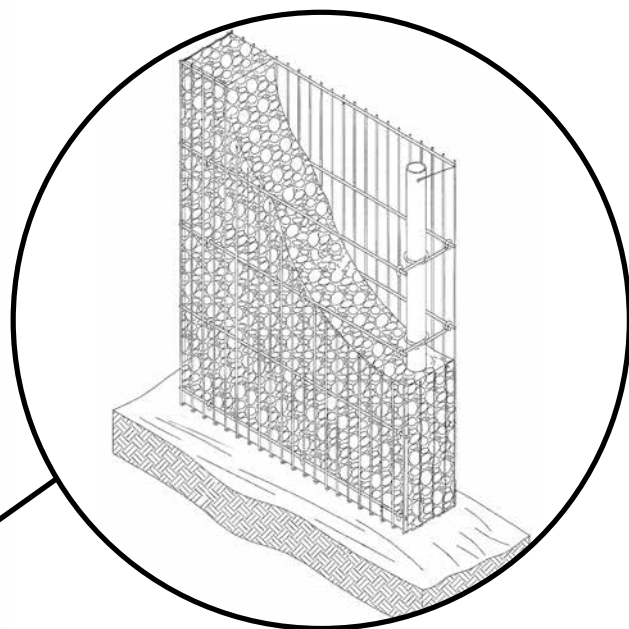
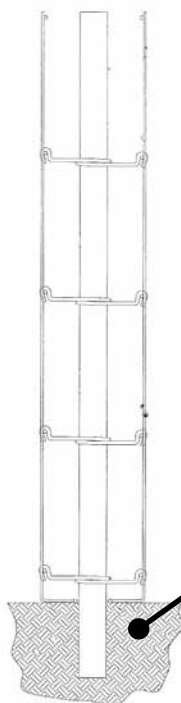

SCARICA le istruzioni di montaggio per maggiori dettagli.

TÉLÉCHARGEZ les instructions de montage pour plus de détails.

LADEN SIE die Montageanleitung herunter, um weitere Informationen zu erhalten.

DOWNLOAD the assembly instructions for more details.

MINI GABION

DIY

Mini gabbione metallico ideale per realizzare bordure o piccoli elementi decorativi in giardino.

Mini gabion métallique idéal pour réaliser des bordures ou de petits éléments décoratifs dans le jardin.

Mini-Gabione aus Metall, ideal für die Herstellung von Rabatten oder kleinen dekorativen Elementen im Garten.

Mini metal gabion ideal for making borders or small decorative elements in the garden.

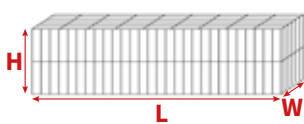
	L [cm]	W [cm]	H [cm]	PESO - POIDS GEWICHT - WEIGHT [kg]	
				VUOTO VIDE LEER EMPTY	RIEMPIMENTO REPLISSAGE FÜLLUNG FILLING
	80	10	15	1,5	18



DOTATO DI TIRANTI PER GARANTIRE LA FORMA E LA SOLIDITÀ

Equipé de tirants pour assurer forme et solidité
Ausgestattet mit Zugstangen, um Form und Stabilität zu gewährleisten
Equipped with tie rods to ensure shape and solidity

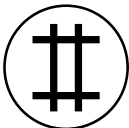

MAGLIA: 1x7 cm, GRANULOMETRIA CONSIGLIATA 12-16 mm

Maille : 1x7 cm et granulométrie recommandée 12-16 mm
Maschengröße: 1x7 cm, empfohlene Körnung 12-16 mm
Mesh size: 1x7 cm, recommended granulometry 12-16 mm



FORNITO CON ETICHETTA E GIÀ MONTATO

Fourni avec une étiquette et déjà assemblé
Lieferung mit Etikett und bereits montiert
Supplied with label and already assembled

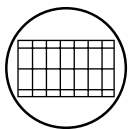

FORNITO ESCLUSIVAMENTE VUOTO

Livré uniquement vide
Wird nur leer geliefert
Supplied empty only

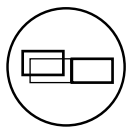

UNA VOLTA POSIZIONATO PUÒ ESSERE SPOSTATO

Une fois positionné il peut être déplacé
Sobald es positioniert ist, kann es verschoben werden
Once positioned it can be moved



UN PRODOTTO IDEALE PER IL FAI DA TE

Un produit idéal pour le bricolage
Ein ideales Produkt für Heimwerker
An ideal product for DIY

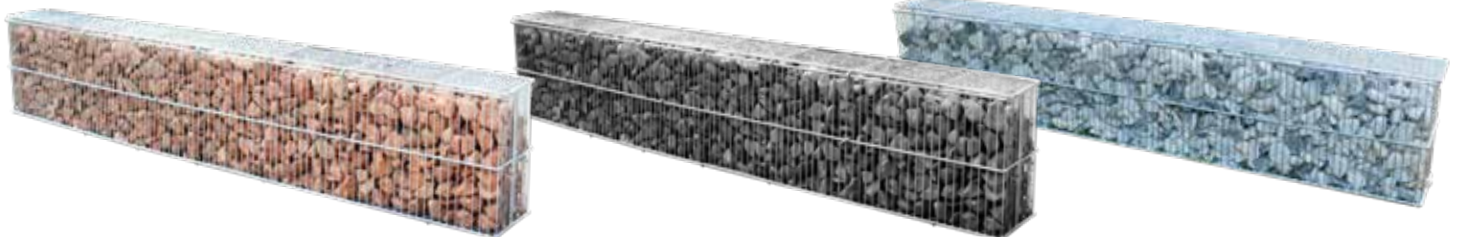







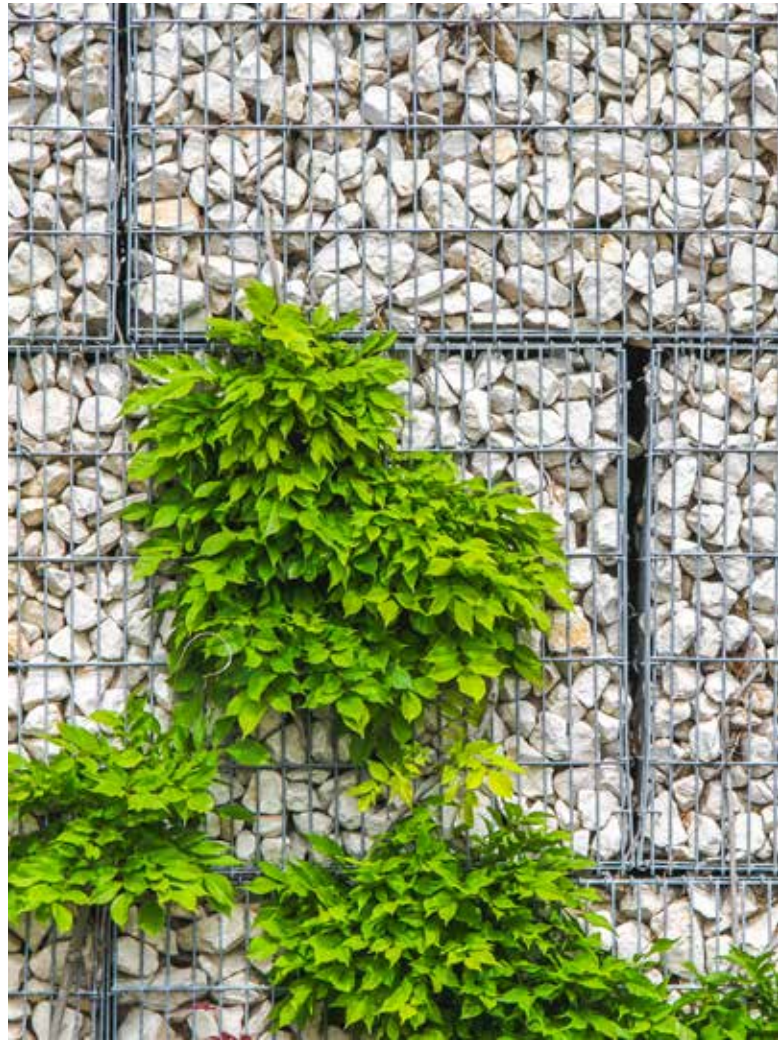



NATURAL STONE BOX



DOWNLOAD AREA

www.stonebox.it

GRANULATI ZANDOBBIO S.p.A. - Via Selva, 29 24060 Zandobbio (BG) - Italy - info@granulati.it - www.granulati.it
Expo STONE CITY - Via Europa, 38 24060 Bolgare (BG) - Italy - www.stonecity.it